

## INSTALLATION INSTRUCTIONS

Install data jacks as described in the installation instructions provided with data adapters, BE01421

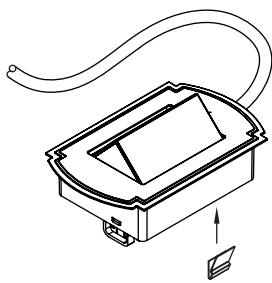

1

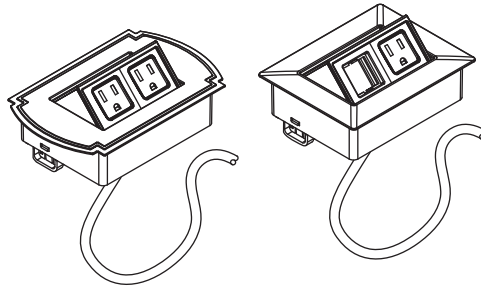
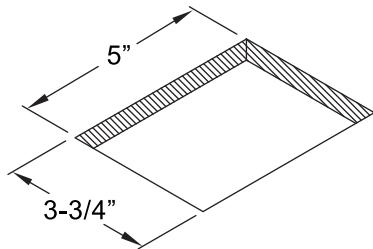
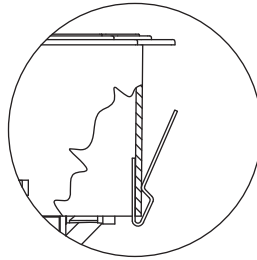

Attach 1 clips, at back of unit base.

**Note: Metal clips are for use in hard surface material only as an optional mounting means**

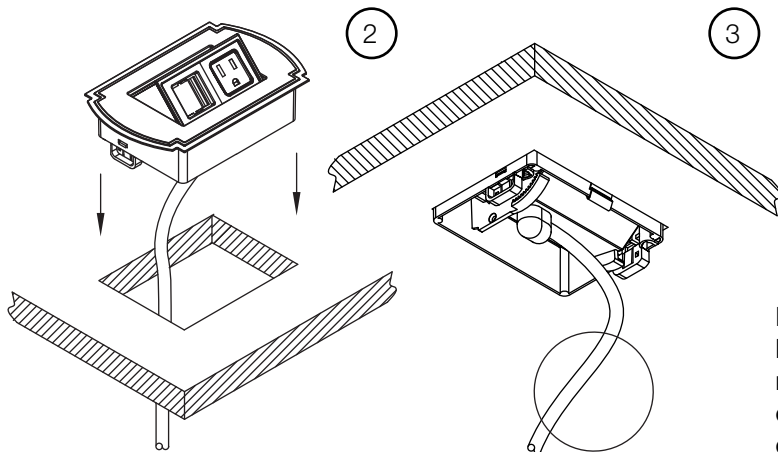

2

3

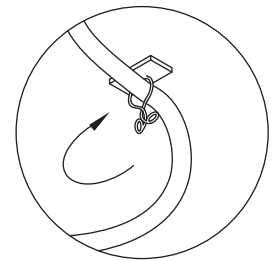
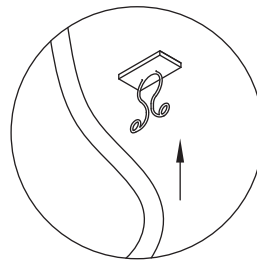

**Note: In a conduit application, conduit should be supported according to local code. When managing conduit and cabling exiting the unit, ensure there is adequate slack to allow unit to open properly**

4

