

ERK basic dimensions

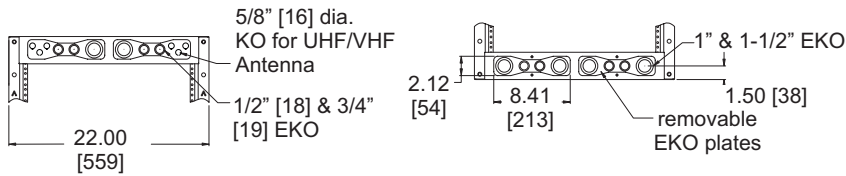

REAR VIEW, TOP & BOTTOM



TOP VIEW OF ERK SIDE SECTIONAL VIEW

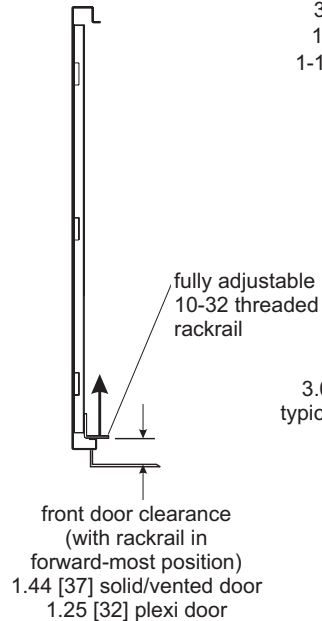

REAR VIEW SIDE VIEW FRONT VIEW

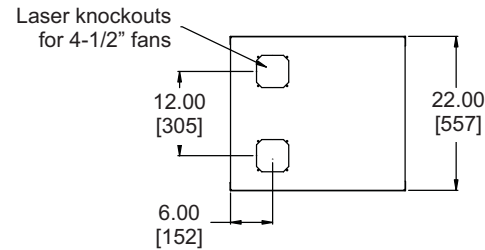
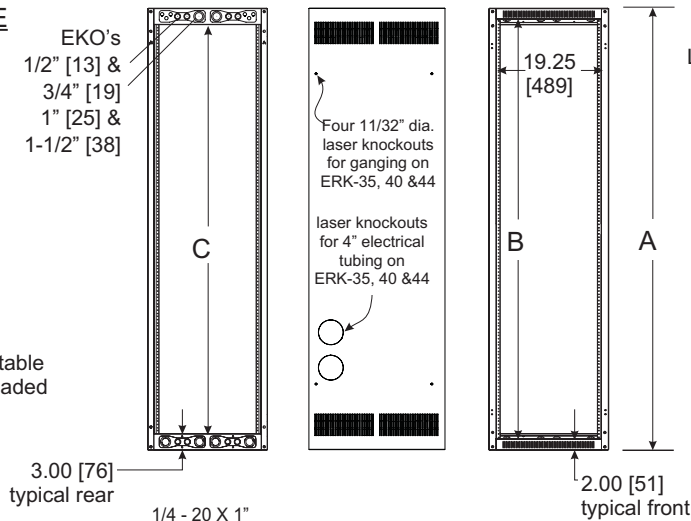

TOP VIEW
ERK-18XX
ERK-21XX
ERK-27XX

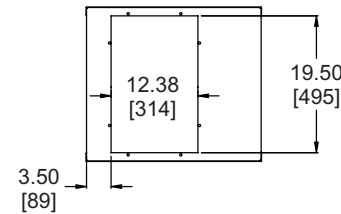

TOP VIEW
ERK-35XX
ERK-40XX
ERK-44XX

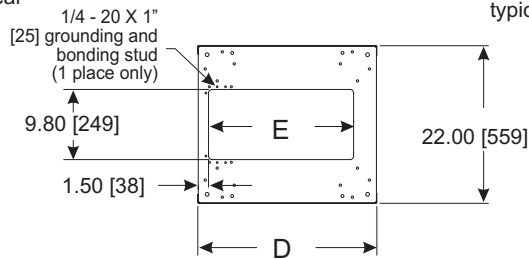

BOTTOM VIEW

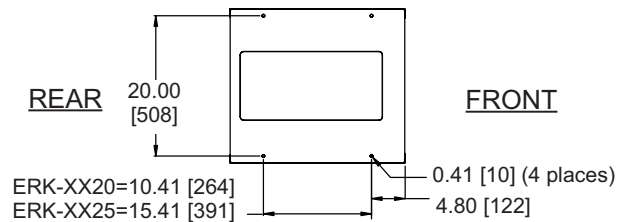

BOTTOM VIEW mounting holes

All dimensions in inches unless otherwise noted [All dimensions in brackets are in millimeters]

Part #	A Overall Height	B Useable Height	C Rear Height	D Overall Depth	E Bottom Opening Depth
ERK-4425	81.125 [2061]	77.125 [1959]	75.125 [1908]	25.00 [635]	20.25 [514]
ERK-4025	74.125 [1883]	70.125 [1781]	68.125 [1703]	25.00 [635]	20.25 [514]
ERK-3525	65.375 [1661]	61.375 [1559]	59.375 [1508]	25.00 [635]	20.25 [514]
ERK-2725	51.375 [1305]	47.375 [1203]	45.375 [1153]	25.00 [635]	20.25 [514]
ERK-2125	40.875 [1038]	36.875 [937]	34.875 [886]	25.00 [635]	20.25 [514]
ERK-1825	35.625 [905]	31.625 [803]	29.625 [752]	25.00 [635]	20.25 [514]
ERK-4420	81.125 [2061]	77.125 [1959]	75.125 [1908]	20.00 [508]	15.25 [387]
ERK-4020	74.125 [1883]	70.125 [1781]	68.125 [1703]	20.00 [508]	15.25 [387]
ERK-3520	65.375 [1661]	61.375 [1559]	59.375 [1508]	20.00 [508]	15.25 [387]
ERK-2720	51.375 [1305]	47.375 [1203]	45.375 [1153]	20.00 [508]	15.25 [387]
ERK-2120	40.875 [1038]	36.875 [937]	34.875 [886]	20.00 [508]	15.25 [387]
ERK-1820	35.625 [905]	31.625 [803]	29.625 [752]	20.00 [508]	15.25 [387]
ERK-4425-AV	81.125 [2061]	77.125 [1959]	75.125 [1908]	25.00 [635]	20.25 [514]
ERK-4025-AV	74.125 [1883]	70.125 [1781]	68.125 [1703]	25.00 [635]	20.25 [514]
ERK-3525-AV	65.375 [1661]	61.375 [1559]	59.375 [1508]	25.00 [635]	20.25 [514]

Top options

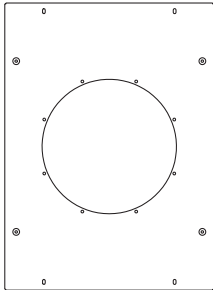

ERK-10FT
accepts 10" fan

ERK-10FT- 550CFM
includes 10" fan

ERK-10FT-FC
includes 10" fan and
fan controller

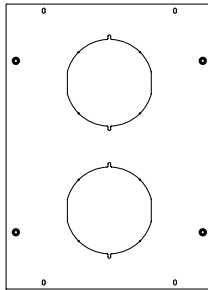

ERK-6FT
accepts two 6" fans

ERK-6FT- 440CFM
includes two 6" fans

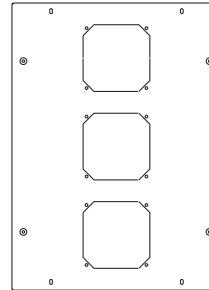

ERK-4FT accepts
three 4-1/2" fans

ERK-4FT- 285CFM
includes three
4-1/2" fans
(included in A/V
enclosures)

ERK-4FT-FC
includes 4-1/2"
quiet fans and fan
controller

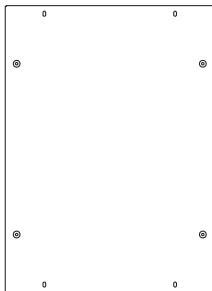

ERK-ST
solid

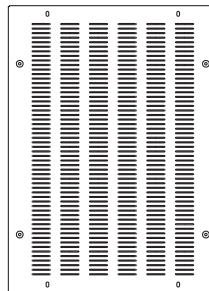

ERK-VT
slot vent

ERK A/V Enclosure Power Distribution

Rack Part #	Part #	Terminated	Circuit	Outlets	Overall Length	Qty
ERK-4025-AV / ERK-3525-AV	PDT-1020C-NS	5-20P	20 Amp	10, 5-20R	37.75 [959]	2
ERK-4425-AV	PDT-2020C-NS	5-20P	20 Amp	20, 5-20R	72.75 [1848]	1

ERK A/V Enclosure Vertical Lacer Bar Chart

Part #	Lacer Bar	Number of Rackspace	Width
ERK-4425-AV	LACE-44-OP	44	3.25 [83]
ERK-4025-AV	LACE-40-OP	40	3.25 [83]
ERK-3525-AV	LACE-37-OP	37	3.25 [83]